

**ROCKSOLAR®**

# BLP SERIES

PURE SINE WAVE INVERTER

USER MANUAL

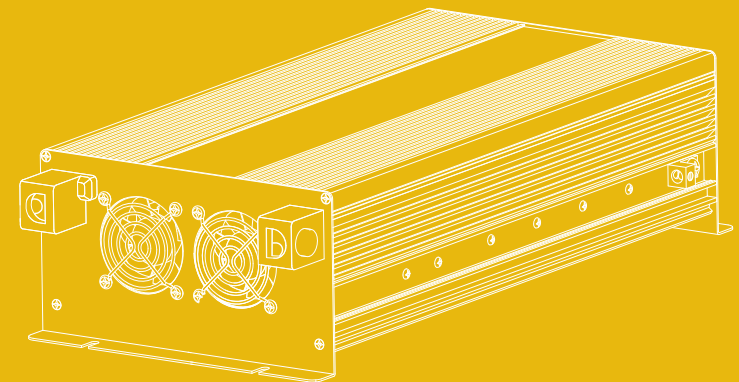

## **ROCKSOLAR TECHNOLOGY LLC.**

Address: 500 DELAWARE AVE,STE 1 #1960 WILMINGTON,DE,US,19899

Tel: 1-800-858-4318

Email: [services@rocksolars.com](mailto:services@rocksolars.com)

Website: [www.rocksolars.com](http://www.rocksolars.com)

## CATALOG

1. Attention and Warning .....	3
2. Product Description .....	4
3. Inverter Application .....	5
4. Appearance .....	7
5. Product Installation .....	9
6. Product Parameter List .....	13
7. Display Function .....	14
8. Display and Control Panel .....	15
9. Total Harmonic Distortion(THD) .....	18
10. General Technical Requirements .....	18
11. DC Input Cable Requirements .....	18
12. Features .....	18

### Please keep it properly after reading

In order to ensure reliable service for you, the inverter must be installed and used properly. Before installation and use, please read the installation and operating instructions. Please pay special attention to the warnings and their explanation in this manual, for some warning of use conditions and practice caution that can lead to inverter damage. And the clear warning statement for certain conditions of use and practices which are likely to cause personal injury. Read all tips before using the inverter.

Please read this instruction manual carefully to facilitate the correct use. Especially before using, please remember to read the details of the "Safety Precautions" to ensure safe use. After reading the instruction manual, please keep it properly for future reference.

### Accessories:

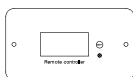

**Remote control panel**  
(Optional, need to be purchased separately)

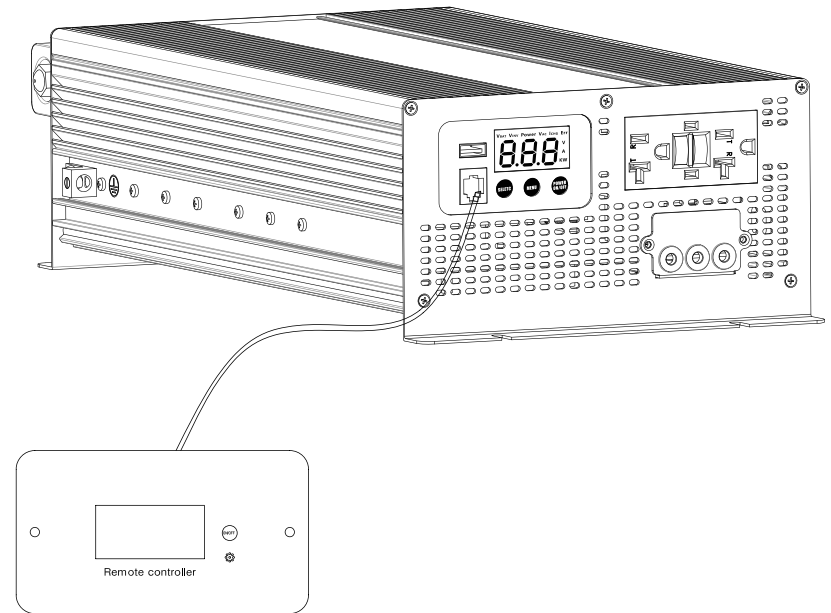

**BLP1000ARW-\*** • **BLP1000BRW-\***  
**BLP2000ARW-\*** • **BLP2000BRW-\***  
**BLP3000BRW-\*** • **BLP3000BRW-\***

**USER MANUAL**

(Note: The "\*" represents different AC output socket; for example, "EU" represents European socket; "UK" represents United Kingdom socket; "FR" represents French socket;)

The picture is for reference only, please refer to the actual product, we have the final interpretation of the product.

## 1 Attention and warning

- Be sure to read this manual carefully before use;
- The machine should be handled with care
- If the equipment is damaged due to failure of installation in accordance with this manual, company reserves the right not to carry out quality assurance.



**WARNING**

- To prevent fire, do not cover or block the ventilation holes. Do not install inverter in zero clearance compartments, which may cause overheating.
- The machine itself has overload protection to prevent overload. Do not operate or install on a flammable surface. Reverse polarity can damage the device.
- To avoid harm to you and others, here we list all precautions as below, please be sure to follow, please refer to the description for the meaning of various signs.



**Caution the surface with high temperature Attention surface a haute temperature.**



### Flammable gas

Sparks when connecting the battery, before connecting, make sure there is no flammable gas. The battery will be easy to emit flammable gas while charging and discharging. Requesting well ventilation, do not put it in the places which will accumulate flammable gas.



### Prohibition in parallel with city power

The output can not be connected in parallel with the mains, which will damage the inverter and cause the electric shock.



### Prohibition of minors

Can not be used by minors, inverter has a high voltage output, which may lead risk of electric shock.



### No disassembly

Do not disassemble or modify this inverter. Unauthorized disassembly or modification may cause malfunction, and security incidents such as fire disasters or electric shocks.



### Prohibition contact with sticks

Do not place a stick or other metal object in the inverter hole or jack, which may touch internal parts to cause electric shock and damage to the inverter.



### Do not touch with wet hands

Do not touch the inverter body and the plug with wet hands, this may cause electric shock and personal safety.



### Keep away from flames and high temperature area

Operating in flame and high temperature area, may lead inverters and batteries to occur fire or explosion.



### No collision

Crashing the inverter will cause the damage and other safety risks.



### Prohibition for medical devices

The inverter can not be used for medical equipment before testing.



### Ground wire connection

For electricity safety, please connect the inverter to ground, or may cause a safety accident.



### Moisture proof and waterproof

Please pay attention to moisture and water proof, inverter may cause short circuit, fire and electric shock because of moisture or water.

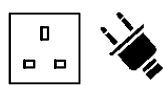

### Complete insertion

Please insert the load device plug into the inverter socket completely. If the plug is not fully inserted at the end, it may lead to electric shock and overheating, and even cause a fire accident. Do not use damaged plugs, power outlets, electrical wires.

## 2 Product Description

Thank you very much for choosing our products and thanks for your trust and support. At present, our products have gotten Chinese and foreign customer's consistent praise. We sincerely hope that this product can meet your needs, at the same time, we hope that you can give more advices about the performance and function of our product, we will continue to improve the quality of our products. Should you have any abnormalities during use, please contact us immediately, we will provide the fastest service for your satisfaction.

BLP series, the remote controlled intelligent inverter, is a newest power solution developed by our company for complex power demand, as users in the digital age have a higher demand for efficiency and flexibility. User-friendly design, innovation and fashion elements of BLP series inverters enable us to seamlessly experience in complex application loads and perfect solution of security, reliability, plug-and-play.

BLP series inverter is a kind of power device that converts direct current (battery, solar cell, wind turbine, etc.) to alternating current. This series of inverters can be used for home, outdoor, car, boat and other environments. The inverter uses a wired remote control display panel to show the working status of the inverter and turn on/off function. The inverter function can be set through display control panel button on the host, to meet the needs of different user.

## Remotely controllable multi-function intelligent inverter

- Support wired remote control
- High conversion efficiency
- Multiple protection functions
- Adjustable parameters
- Multiple output interface
- Plug and play
- Full metal casing
- Intelligent cooling fan

Provide input DC12V/24V, output AC100V/AC110V/115V/120V

A variety of power 1000W / 2000W / 3000W .....

A variety of combinations for your choice



Power supply for vehicle equipment



Solar / Home power generation



power supply for ship equipment

### 3 Inverter application

3.1 The inverters of BLP series can be the core component of the solar off grid power generation system as well as the independent power supply system.

#### Off-grid solar power generation system configuration diagram

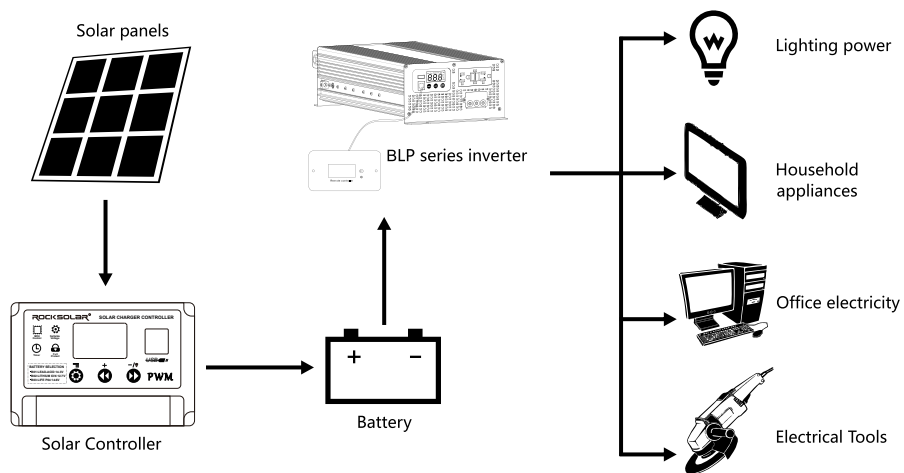

Inverter, solar controller, solar panel, battery can form a set of off-grid solar power generation systems.

#### Inverter independent power supply configuration diagram

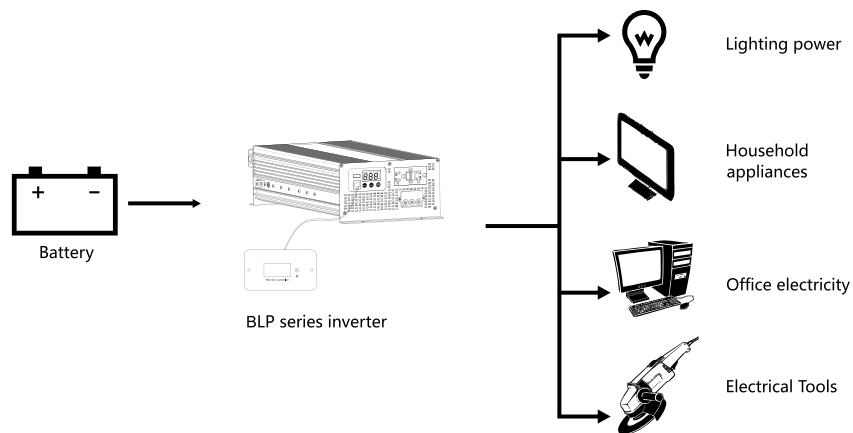

The inverter and the battery can form an independent power supply system, the loaded equipment and the time of use depend on the inverter output power and battery capacity. The inverter can not charge the battery. If you need to charge the battery, please purchase a charger separately.

3.2 BLP series pure sine wave inverter can be used for home, office, car, boat and outdoor emergency power supply, can be used in the following types electrical appliances:

1. household appliances: TV, speakers, amplifiers, refrigerators, air conditioners, electric fans, induction cookers, microwave ovens, electric ovens, consumer ,poison cabinets, hair dryers, electric heaters, vacuum cleaners, fruit oars, rice cookers, water heaters...
2. Office equipment: computers, printers, copiers, network equipment, projectors.
3. Lighting equipment: LED lights, white lights, fluorescent lights, energy-saving lamps.
4. Power tools: electric drills, cutting machines, fans, pumps, hand grinders.



Scope of application

#### Rated current and actual equipment

The BLP series inverter is a pure sine wave inverter, and its output waveform is the same as mains. The nominal current or power of most electric tools, household appliances, and audio-visual equipment is within the nominal power range of the inverter, but there will an overload protection when starting some electrical equipment.

Some audio and video equipment and electric tools have to be more than resistive load level of power for working preper, asynchronous motors, CRT TV, compressor, water pump, etc. request 2 to 6 times of working current when starting. Weather it can run depends on the test.

**This series of inverters CAN NOT be used for medical equipment.**

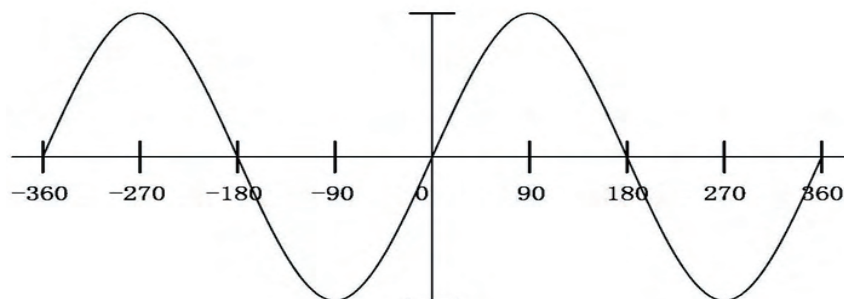

Pure sine wave working diagram

## 4 Appearance

### 4.1 Product Size

#### BLP1000ARW-\*/BLP1000BRW-\* Product Size

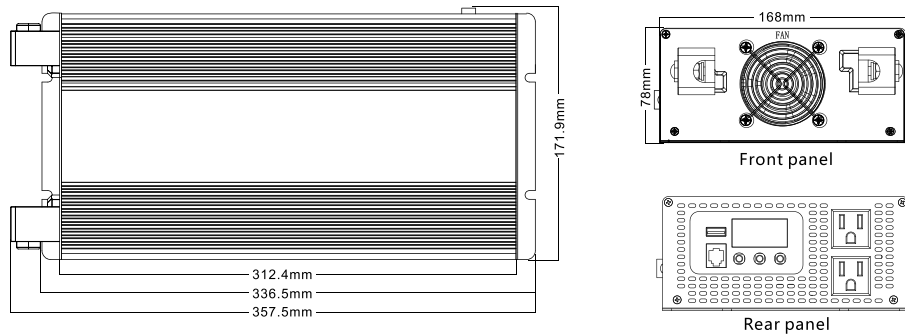

#### BLP2000ARW-\*/BLP2000BRW-\* Product Size

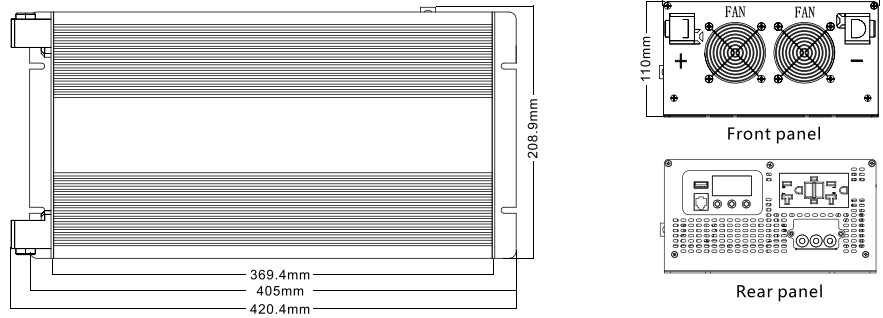

#### BLP3000ARW-\*/BLP3000BRW-\* Product Size

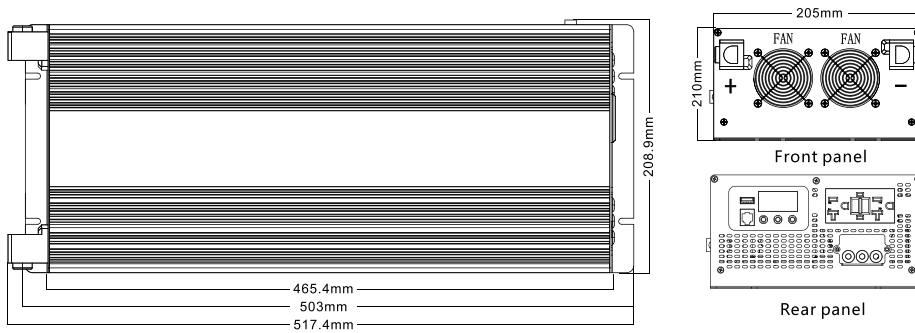

### 4.2 Appearance diagram

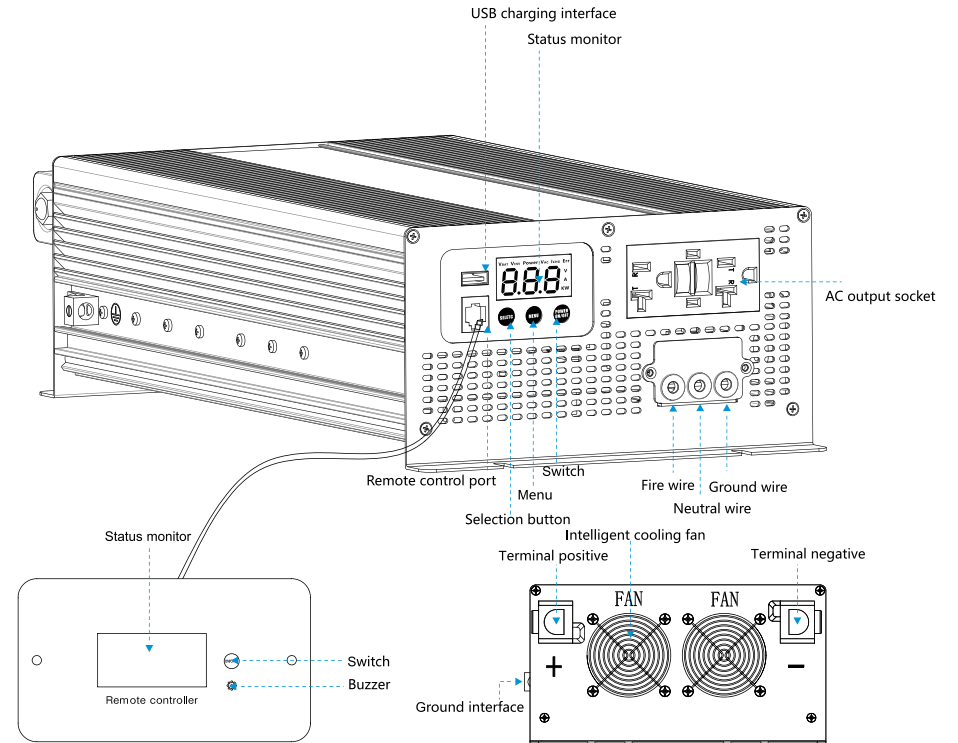

#### American standard regular socket and American standard GFCI socket

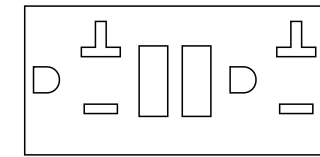
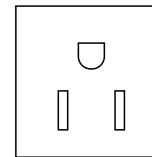

## 5 Product installation

### 5.1 Product Installation

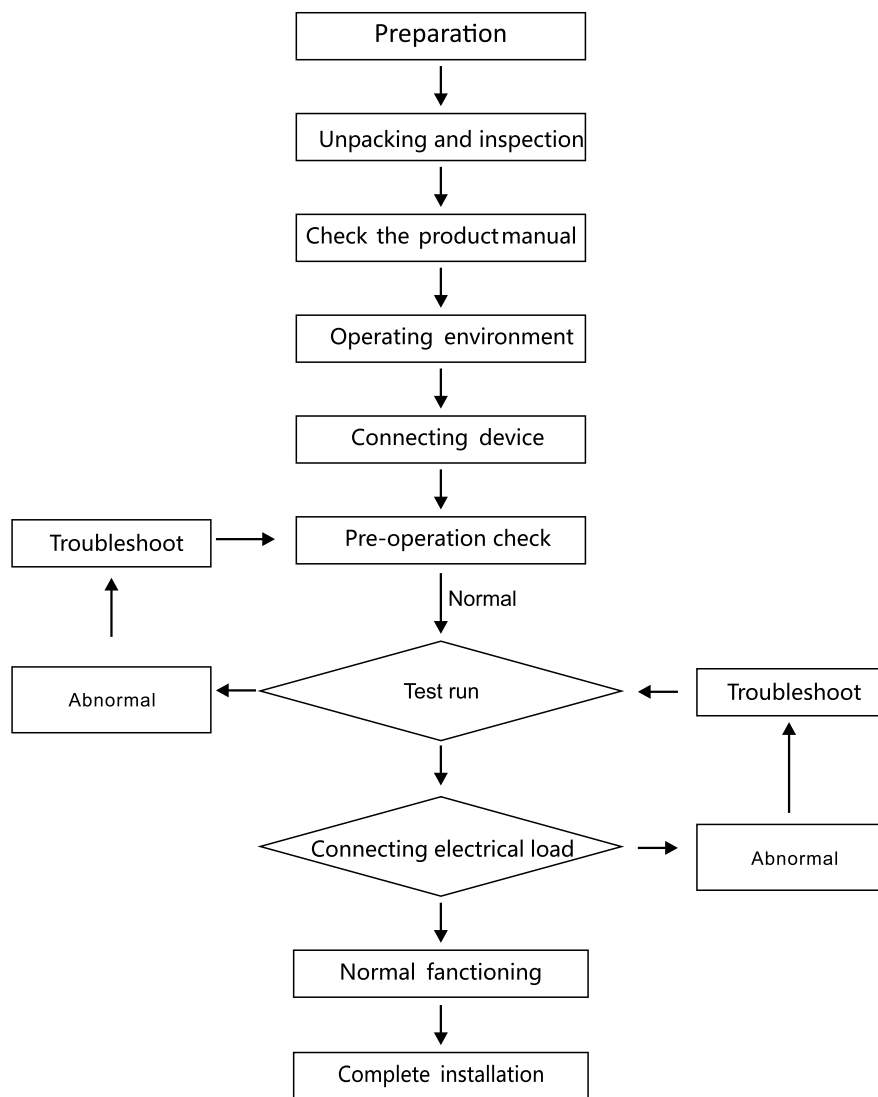

**Production installation flowchart**

### 5.2 Unpacking inspection

Please check the body if any damage when unpacking and contact the supplier immediately if the machine is obviously deformed. Please check the label of the device to confirm if the model, input power, input voltage, and output voltage meet the requirements of your purchase. You can confirm the appearance, structure and model refer to the specification. If any missing parts or damage in transportation, please contact our after-sales department in time and keep the packaging materials for future transportation.

### 5.3 Check the product manual

In order to ensure the product to work normally, please check the manual carefully before using and keep it properly.

### 5.4 Operating environment

In order to ensure the perfect performance and long lifespan of the product, the installation location of the inverter should be protected from the following conditions,

1. This product should be placed indoors and well ventilated;
2. Avoid using in direct sunlight, exposure, rain, high humidity, corrosive gas and mechanical shock;
3. Working temperature/humidity is -20~40°C/10-90%RH, no condensation. Storage temperature/ humidity -30-60 ° C / 10-95% RH;
4. The package drop test follows the IATA standard.

### 5.5 Operation equipment connection

#### 5.5.1 Connection diagram

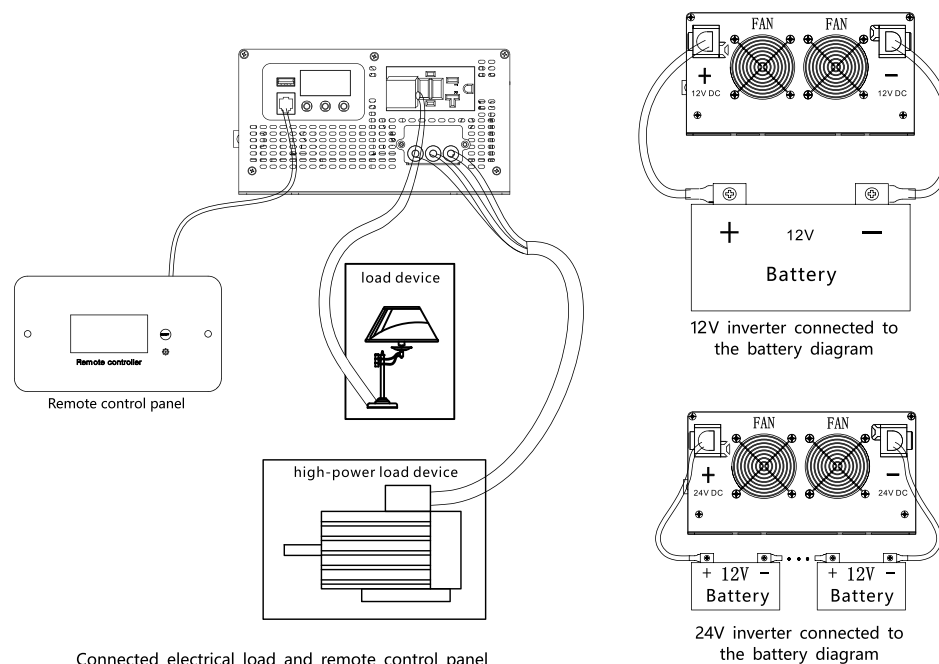

Connected electrical load and remote control panel

### 5.5.2 Installation and connection steps, refer to the connection diagram

1. Connect the negative pole of the battery to the black terminal of the inverter with a black cable;
2. Connect the positive pole of the battery to the red terminal of the inverter with a red cable;
3. Connect the remote control panel to the remote output interface of the inverter;
4. Turn on the power switch of the inverter;
5. Connect the power plug of the loaded equipment to the output socket of the inverter.

### 5.5.3 Removal steps:

1. Turn off the power switch of the inverter;
2. Remove the remote control panel.
3. Unplug the power plug of the load.
4. Remove the battery positive cable;
5. Remove the battery negative cable;

### Warnings

1. The wiring diagram is only for basic reference. Please contact a professional technician for actual installation.
2. Inverter must be connected to the battery, same as nominal voltage, 12V inverter connects 12V battery and 24V inverter connects 24V battery;
3. Appropriate cable should be used when installing and connecting output cables, such as 110V output cable is too long or the cross-sectional area of the wire when it is too small, it will generate a lot of power loss on the cable, 1000W load uses cable  $\geq 16$ AWG, 2000W load use cable  $\geq 14$ AWG, 3000W load  $\geq 12$ AWG.
4. The connection cable between the battery and the inverter is not standard, like overlength cable, too small cross-sectional area and poor contact in connection, it may cause lots of power loss, performance as insufficient output power, low battery voltage, short working time, even not working with alarm when turn on. At the same time, the cable should have waterproof function and insulation strength to meet the requirements of the use environment.
5. When choosing a battery for the inverter, it is better to choose a battery with 100AH or larger capacity.

### 5.5.4 Installation guide

1. Whether you buy the wire from the original factory or use your own one, the wires must have the copper wire with enough carrying.
2. The wire is connected from the battery to the fuse and then to the host, the fuse will provide the insurance in case of fault. If using isolation switch, make sure the fuse rating matching the host power.
3. For ships or vehicles, it is recommended to use multiple AC flexible cables.

### 5.5.5 Remote control installation

When the inverter host is closed, connecting one end of the communication line with a magnetic ring to the inverter host, and the other end to the wiring port of the remote panel.

### 5.5.6 Installation dimension drawing

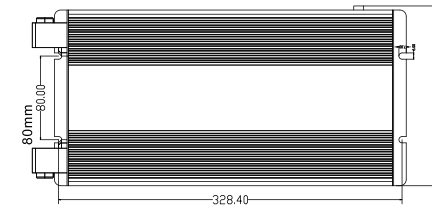

BLP1000ARW-\*/BLP1000BRW-\* Inverter installation size

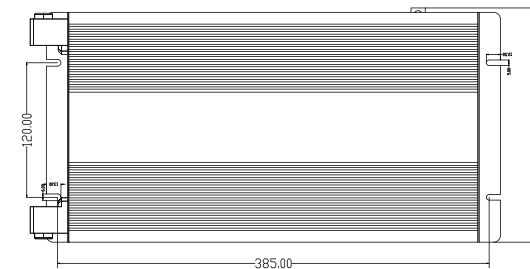

BLP2000ARW-\*/BLP2000BRW-\* Inverter installation size

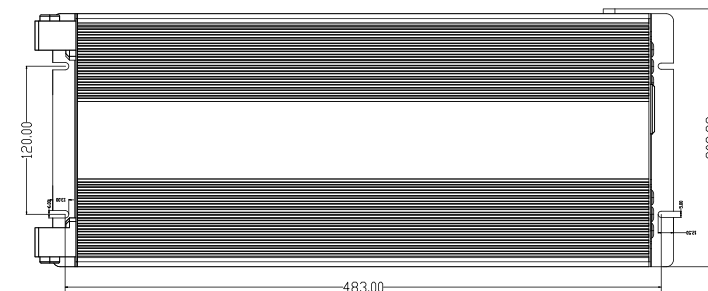

BLP3000ARW-\*/BLP3000BRW-\* Inverter installation size

## 6 Product parameter list

Model		BLP1000ARW-*	BLP2000ARW-*	BLP3000ARW-*	BLP1000BRW-*	BLP2000BRW-*	BLP3000BRW-*	
Output	Rated Power	1000W (30 minutes) 900W (continuous)	2000W (30 minutes) 1800W (continuous)	3000W (30 minutes) 2700W (continuous)	1000W	2000W	3000W	
	AC Voltage	100V/110V/115V/120V						
	Frequency	50Hz/60Hz(Adjustable)						
	Peak Power	2000W	4000W	6000W	2000W	4000W	6000W	
	Total Harmonic Distortion(THD)	≤5						
Input	Battery Voltage	12V			24V			
	Voltage Range	9V-17V			18V-32V			
	DC Current	96A	194A	291A	46A	92A	139A	
	No load Consumption	1.2A	1.5A	2A	0.6A	0.7A	1.1A	
	Quiescent Current in Shutdown Mode	1mA			1mA	1mA	1mA	
	Max Efficiency(full load)	90%			91%			
	Battery Type	lithium battery, lead acid battery, valve control battery and gel battery;						
Battery input protection	Fuse	35A*4	300A*1	400A*1	40A*2	150A*1	200A*1	
	Low Battery Alarm	9.5/10/10.5/11/11.5/12/12.5V, Buzzer alarm, E06 in LED monitor			19/20/21/22/23/24/25V, Buzzer alarm, E06 in LED monitor			
	Recovery of Battery Low Voltage Alarm	10/10.5/11/11.5/12/12.5/13V			20/21/22/23/24/25/26V			
	Low voltage Protection	9/9.5/10/10.5/11/11.5/12V(Adjustable), E01 in LED monitor, inverter will turn off automatically in 30S			18/19/20/21/22/23/24V(Adjustable), E01 in LED monitor, inverter will turn off automatically in 30S			
	Recovery of Low Voltage Protection	Recovery in 30S:11/11.5/12/12.5/13/13.5/14V			Recovery in 30S:22/23/24/25/26/27/28V			
	High Voltage Protection	17V, E02 in LED monitor, inverter will turn off automatically in 30S			32V, E02 in LED monitor, inverter will turn off automatically in 30S			
	Recovery of High Voltage Protection	Recovery in 30S: 16.5V			Recovery in 30S: 31V			
	Battery reverse connection protection	When input DC polarity is connected reversely, the fuse will blow to protect the parts of the inverter from being damaged						
	Output protection	High Temperature Alarm	Buzzer alarm, E07 in LED monitor					
		Over Temperature	Buzzer alarm, inverter stops working with E04 in LED monitor, recovery after temperature reduction					
Short Circuit		Short circuit protection is locked, buzzer alarm, E03 in LED monitor, inverter will turn off automatically in 30S						
Over Load Alarm		Buzzer alarm, E08 in LED monitor						
Overload Alarm		Buzzer alarm, E05 in LED monitor, inverter will turn off automatically in 30S						
USB	Single USB output Voltage	5V/ 9V						
	Single USB output Current	2.1A						
Working environment	Cooling Method	Internal fan of the machine						
	Working Temperature	-20-40°C						
	Working Humidity	10-90%RH						
	Storage Temperature/Humidity	-30°C-+70°C, 10-95%RH						
Packing	N.W.	2820g	5010g	6640g	2820g	5010g	6640g	
	Size/mm (L×W×H)	357.5*172*78	420.4*208.9*110	517.4*208.9*110	357.5*172*78	420.4*208.9*110	517.4*208.9*110	
Remark	All the parameters are measured in environment temperature 25°C if not specified.							

## 7 Display function

### 7.1 Host display: three-digit LED seven-segment digital tube for display

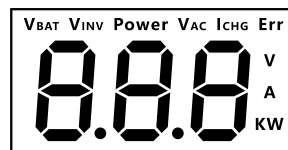

**VBAT:** When VBAT is lit, it indicates DC input voltage.

**VINV:** When VINV is lit, it indicates the inverter output voltage.

**POWER:** When the POWER is lit, it indicates the inverter output power.

**VAC:** This machine does not have this feature.

**ICHG:** This machine does not have this feature.

**ERR:** When ERR is lit, it indicates that the inverter has a fault or warning.

You can check the fault information through the error code of the digital display tube.

### 7.2 Inverter fault and removal method

Error code	Malfunction	Fault description	Method of exclusion
E01	Battery low voltage protection	The battery voltage is too low and the inverter automatically turns off the output.	Check if the battery cable is loose or check if the battery capacity is too small
E02	Battery High Voltage Protection	The battery voltage is too high and the inverter automatically turns off the output.	Check the battery voltage or determine if there is an external charger connection that causes the voltage to be too high
E03	Inverter Output Short-circuit Protection	Inverter output short circuit, inverter automatically closes output	Check if the AC output cable is shorted. Disconnect or reduce the electrical load and turn the inverter back on
E04	Inverter Over Temperature Protection	The internal temperature of the machine is too high and the inverter automatically turns off the output.	Check if the ventilation of the machine is good and the working environment temperature is too high. Wait for the machine to automatically cool down and automatically restore the output.
E05	Inverter Overload Protection	The inverter output is overloaded and the inverter automatically turns off the output.	Check if the power load is too large, disconnect or reduce the power load, and turn the inverter back on.
E06	Battery Low Voltage Alarm	Low battery voltage, machine alarm	Turn off the load and charge the battery
E07	Inverter Over Temperature Alarm	The internal temperature of the machine is too high, close to the limit of the machine	Reduce the electrical load and check if the machine is well ventilated and the ambient temperature is too high.
E08	Inverter Overload Alarm	The power load is too large, close to the limit of the machine	Reduce the electrical load
E09	Inverter Output Over Voltage Protection	Inverter output voltage is too high	Disconnect the power load, turn the machine back on, and check if the machine is normal.

### 7.3 Wired remote control panel with LCD display

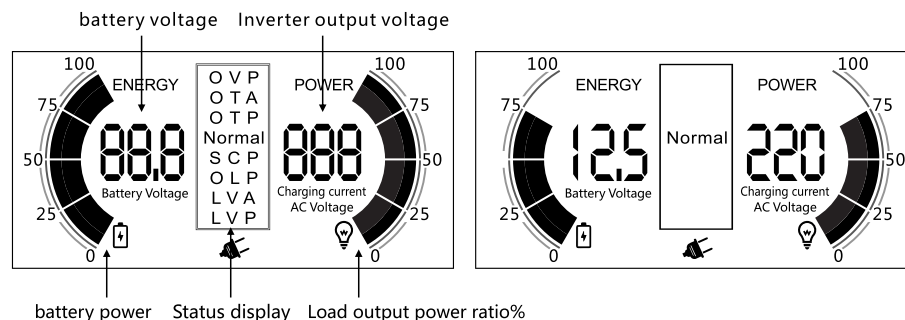



## 8 Display and Control panel

The display panel can be operated remotely via a 6pin telephone line with a short distance of up to 7 meters.

### 8.1 Keystroke tone:

Press the Power, Select, Menu button at any time, and the buzzer will emit a short beep.

### 8.2 Inverter On/Off:

Turn the inverter on/off, and press the power button on the display panel for about 1 second and hear the beeped sound.

### 8.3 Three LED seven-segment digital tube for display:

- When the inverter is working, the LED digital screen alternately displays: "battery voltage", "inverter output voltage", "inverter output power"
- When the inverter fails, the LED digital screen displays the corresponding error code.

### 8.4 Press the button 'Menu' to view the current inverter display status:

- When the DC input voltage is displayed, the LED screen displays 'VBAT', and the three-segment digital tube displays: '\*\*.\*V
- When the AC output voltage, the LED screen displays 'VINV', the three-segment digital tube displays: '\*\*\*\*V
- When the inverter AC output power, the LED screen displays 'Power', the three-segment digital tube displays: '\*.\*KW

### 8.5 Press the button 'Select' to view the current inverter settings status:

- View inverter output frequency setting LED screen display: '50: output frequency 50HZ/'60: output frequency 60HZ'
- When viewing the inverter function low voltage protection setting, the LED display shows: '9', '9.5', '10', '10.5', '11', '11.5', '12' (12V inverter low voltage protection setting) '18', '19', '20', '21', '22', '23', '24' (24V inverter low voltage protection setting)
- When viewing the buzzer alarm on/off function setting, the LED display shows: 'AL0: buzzer off', 'AL1: buzzer on'
- View inverter AC output voltage setting, LED display shows: '100: Inverter output voltage 100VAC', '110: Inverter output voltage 110VAC', '115: Inverter output voltage 115VAC', '120: Inverter output Voltage 120VAC'
- Inverter AC output function setting, LED screen display: 'IN1: Inverter default setting mode', 'IN2: Inverter power saving mode', 'IN3: Inverter automatic shutdown mode'

### 8.6 Inverter function settings:

- Press the 'menu' button for 5s, and the inverter enters the function setting menu mode:
- LED screen display: 'FE' indicates the frequency setting menu, press 'Select' button 1s to enter the output frequency setting: '50: output frequency rate 50HZ/'60: Output frequency 60HZ', the output frequency can be set by 'Select' button. After the selection is completed, press 'Menu' button 5s, you can save settings and exit the menu setting function; If you need to continue to set other functions, press the 'Menu' button for 1 second to enter the next menu setting. After the next menu is set, press the 'Menu' button for 5s, you can save it together with the last setting, after the save is completed, the menu setting function will be automatically exited.
- LED screen display: 'LV' indicates the battery low voltage protection setting menu, press 'Select' button 1s to select the battery low voltage protection voltage:

'9', '9.5', '10', '10.5', '11', '11.5', '12' (12V inverter low voltage protection setting)

'18', '19', '20', '21', '22', '23', '24' (24V inverter low voltage protection setting)

After the selection is completed, press the 'Menu' button for 5s to save the settings and exit the menu setting function; if you need to continue to set other functions, press the 'Menu' button for 1 second to enter the next menu setting. After the next menu is set, press the 'Menu' button for 5s to save the last set function together. After saving, the menu setting function will be automatically exited.

- LED screen display: 'AL' indicates buzzer alarm setting menu: 'Select' button 1s, select buzzer setting: 'AL0: buzzer off', 'AL1: Buzzer on'; after the selection is completed, press the 'Menu' button for 5s to save the settings and exit the menu setting function; If you need to continue to set other functions, press the 'Menu' button for 1 second to enter the next menu setting. After the next menu is set, press the 'Menu' button for 5s to save the last set function together. After saving, the menu setting function will be automatically exited.
- LED screen display: 'out' indicates the inverter AC output voltage setting menu: press 'Select' button 1s to select inverter AC output voltage setting: '100: Inverter output voltage 100VAC', '110: Inverter output voltage 110VAC', '115: Inverter output voltage 115VAC', '120: Inverter output voltage 120VAC. After the selection is completed, press 'menu' key 5s, you can save settings and exit the menu setting function; If you need to continue to set other functions, press 'Menu' key 1s, will go to the next menu setting. After the next menu is set, press the 'Menu' button for 5s to save the last set function together. After saving, the menu setting function will be automatically exited.
- LED screen display: 'IN' inverter function setting menu: 'Select' key 1s, enter inverter function setting 'IN1: inverter default recognize setting mode', 'IN2': Inverter power saving mode', 'IN3: Inverter automatic shutdown mode'. After the selection is complete, press 'Menu' button 5s, you can save settings and exit the menu setting function; if you need to continue to set other functions, press 'Menu' The key 1s will enter the next menu setting. After the next menu is set, press the 'Menu' button for 5s to save the last setting together. The function will automatically exit the menu setting function after saving.  
IN1: Inverter default setting mode; when the inverter is turned on, the inverter continues working unless there is a fault.  
IN2: Inverter power saving mode; if the AC power load is less than 10W after the inverter is turned on, the inverter will automatically shut down AC output, until the AC power load is larger than 10W, the inverter automatically turns on the AC output.  
IN3: Inverter automatic shutdown mode: if the load power is less than 10W within 30min after the inverter is turned on, the inverter will turn off the AC output and shutdown automatically.
- LED screen display: 'DEF' restores the factory default menu settings. When this mode is set, the factory function settings will be automatically restored: Inverter output frequency: 60HZ, battery low voltage protection voltage: 10V/20v, buzzer alarm: AL1, inverter output voltage: 110V, the inverter function is set to: default mode 'IN1'. Press 'Menu' for 5s to save settings and exit menu setting function; if you need to continue to set other functions, press 'Menu' button 1s, it will enter the next menu setting. In the next menu after setting, press 'Menu' button for 5s to save the last set function together. After saving, it will automatically exit the menu.

## 8.7 Display and control panel

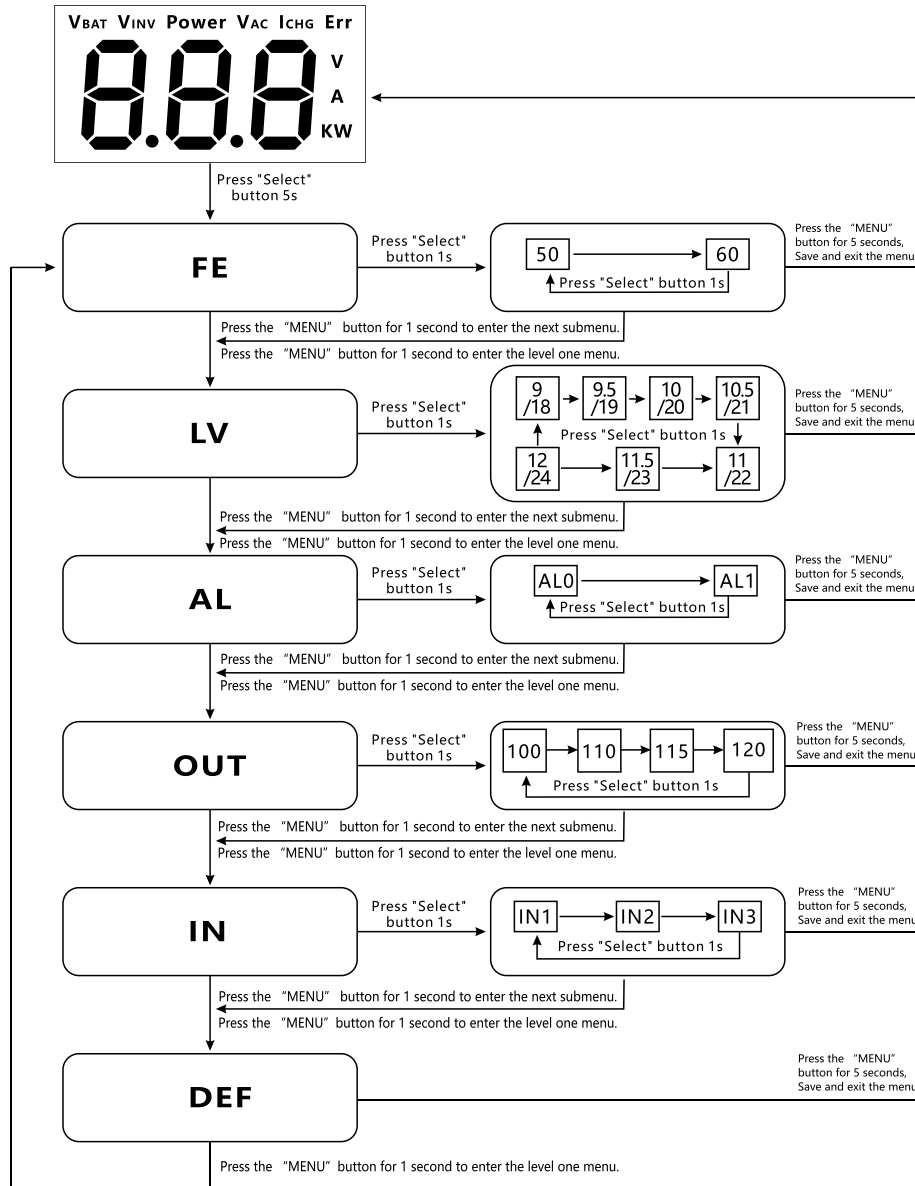

## 9 Total Harmonic Distortion (THD)

The THD of the output: < 5%

## 10 General technical requirements

### 10.1 Operation and storage temperature requirements:

- Normal working temperature: 2 5 °C
- Operating temperature range: -20~ 45°C
- Storage temperature range: - 30~ 60 °C

### 10.2 Operation and storage humidity requirements

- Normal working humidity range: 1 0 – 90 %RH
- Storage humidity range: 10 – 95 %RH

### 10.3 Packaging Drop Test Requirements

Packaging drop test follows IATA standards

### 10.4 Corrosion resistance requirements

All metal parts are treated with oxidation

## 11 DC input wire requirements

- BLP-3000S-12V-\* Wiring: #3/0 AWG (American Standard) or National Standard 80mm<sup>2</sup> Wire length: 1.5 meters max
- BLP-3000S-24V-\* Wiring: #2 AWG (American Standard) or National Standard 30mm<sup>2</sup> Wire length: 1.5 meters max
- BLP-2000S-12V-\* Wiring: #2/0 AWG (American Standard) or National Standard 50mm<sup>2</sup> Wire length: 1.5 meters max
- BLP-2000S-24V-\* Wiring: #2 AWG (American Standard) or national standard 30mm<sup>2</sup> Wire length: 1.5 meters max
- BLP-1000S-12V -\*Wiring: #2 AWG (American Standard)) or national standard 30mm<sup>2</sup> Wire length: 1.5 meters max
- BLP-1000S-24V-\* Wiring: #5 AWG (American Standard) National Standard 16mm<sup>2</sup> Wire length: 1.5 meters max

## 12 Product features

- Provide fan with intelligent control to reduce the running noise effectively, high efficiency operation;
- Touch switch;
- Provide remote control by wired control panel;
- Dual frequency setting, which can be switched between 50Hz and 60Hz frequency;
- Adjustable minimum voltage for low voltage protection of the battery;
- Long lifespan in extreme environmental conditions;
- Output voltage AC 100V, AC 110V and AC 115V and AC120V can be set;
- Low no-load current, saving energy without load;
- High load capacity can bear relatively large loads and handle stably in case of overload;
- Support a variety of batteries, battery types such as lithium battery, lead acid battery, valve control battery and gel battery;
- Provide a variety of intelligent protection:
  - 1, battery low voltage protection and alarm
  - 2, battery over voltage protection
  - 3, overload protection and alarm
  - 4, short circuit protection 5, high temperature protection and alarm
- Provide input/output voltage display functions and USB output;
- Plug and play maintenance-free design ensures long-term continuous operation
- This product is made of metal shell, anti-oxidation process, beautiful appearance.